

## Panel List models listed below

**Note: Separate and stack panels by like types before beginning assembly process.**

1 Desktop Panel • 1 Back Panel • 1 Left End Panel • 1 Right End Panel • 3 Support Panels  
1 Keyboard/Hinge Mechanisms • 2 CPU Bottoms

- = Cam Fitting
- = Cam Hole
- = Screw Hole/Spoon Pin
- = RV Fitting
- ⊗ = Grommet/wire access

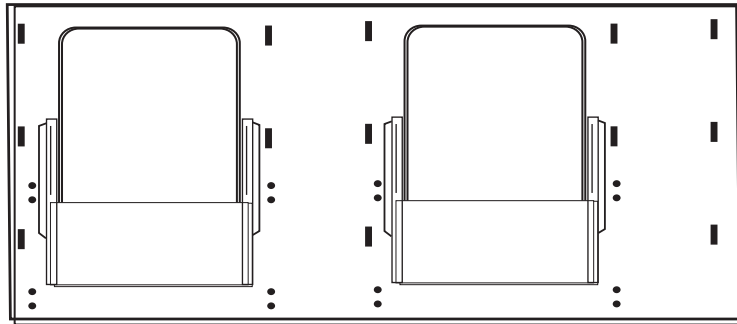

Desktop Panel (1 ea.)

Keyboard/Hinge Mechanism (2ea.)  
Comes attached to Top

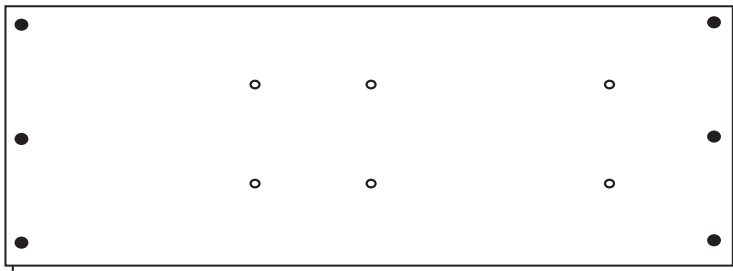

Back Panel (1 ea.)

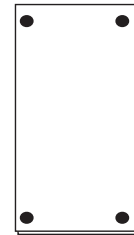

CPU Bottom (2 ea.)

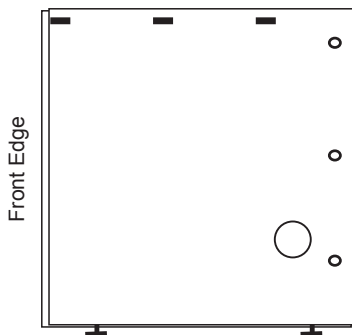

Left End Panel (1 ea.)

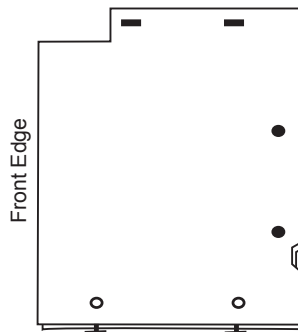

Support Panel (3 ea.)

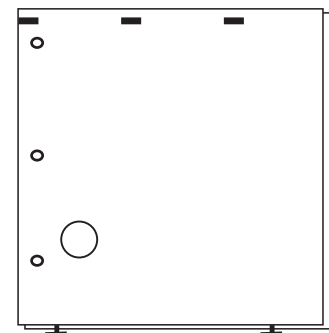

Right End Panel (1 ea.)

The Smartdesk is packaged ready to be assembled. Included is a Master Parts and Panel List showing diagrams of all parts and hardware required for assembly. Please note, improper installation may void Smartdesk warranty. To install correctly follow the enclosed instructions. If you need additional assistance or information please contact Technical Service at 800-770-7042 or email sales@smartdesks.com.

### Smartdesks FI Double Workstations

#### Unpack Parts and Hardware:

Parts and panels will vary according to Smartdesks model. See Parts & Panels List and Hardware Inventory Sheet. Please verify all parts and quantities prior to assembly. Contact the factory if your quantities are incomplete.

*Note: All panels are predrilled ready for assembly.*

*Note: Keyboard/Hinge Mechanism comes preassembled on pull-out hinge attached to Desktop.*

**NOTE: DO NOT CUT THE NYLON CABLE TIE FROM THE KEYBOARD HINGE UNTIL THE DESK IS ASSEMBLED AND UPRIGHT.**

#### Tools needed for assembly:

Power drill with #2 Phillips screwdriver bit and regular #2 Phillips screwdriver.

The following diagram shows the contents of the hardware bag.

Contents of Hardware Bag: (quantities for each unit - multiply by number of components)

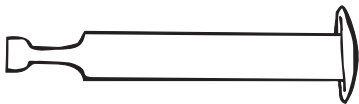

**20 ea. - Cam Pins**  
push through holes in panels,  
(Side Panels, Back Panels,  
Support Panels, CPU Bottom)



**1 ea. - Wire Trough**  
black PVC used to contain  
wiring inside rear of  
Back Panel



DFI-723030-TKF  
DFI-883030-TKF

Figure 1

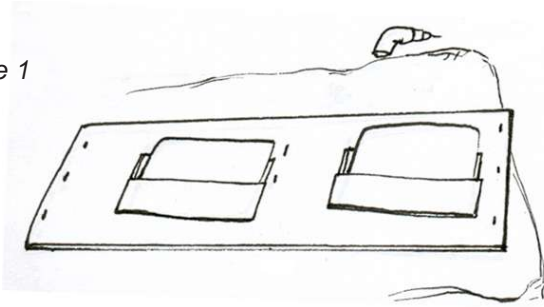

## STEP 1 - Desk Panel & Side Panel Assembly

*NOTE: 2 person assembly required for proper fit.*

**NOTE: DO NOT CUT THE NYLON CABLE TIE FROM THE KEYBOARD HINGES UNTIL THE DESK IS ASSEMBLED AND UPRIGHT.**

In a clean work area lay Desk Top Panel facing down on the floor on cardboard or carpet/packing quilt. (Fig. 1) Lift and place Right Side Panel into 90° vertical position with fittings facing in. While holding right panel in vertical position, match RV Fittings to one another and snap panel into place. Use power drill to tighten the screw contained in the RV Fitting. (Fig.2) Each RV Fitting contains a screw to lock the hardware once the panels have been snapped into place. Warranty is void if all locking screws have not been tightened. RV Fittings come preinstalled in panels and are equally spaced along Desk Top edge. Tighten all remaining RV Fittings along panel edge. (Fig.3)

Repeat STEP 1 for the installation of the Left Side Panel.

Figure 2

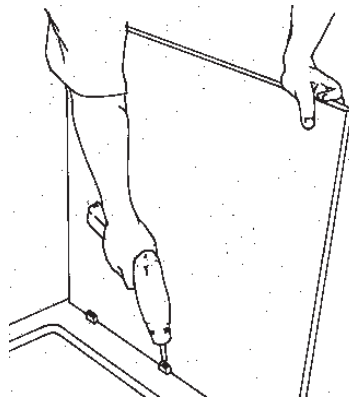

Figure 3

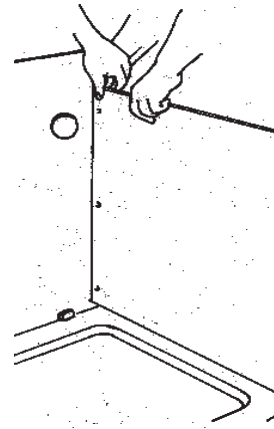
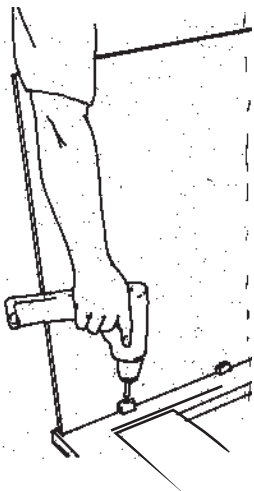

Figure 4

## STEP 2 - Back Panel To Sides Assembly

*NOTE: 2 person assembly required for proper fit.*

Slide Back Panel into position between two Side Panels matching the cam fittings to the holes at top. It is necessary for 2 people to accomplish this assembly. Vertical panels cannot be left standing unsupported (Fig.4) Insert top 2 Cam Pins through Left and Right End Panels into cam fittings. (Fig. 5) Start at the top cam of each end panel when inserting Cam Pins and move down each end panel alternating as Cam Pins are inserted. Make sure arrows on Cam Pins are facing out (3 pm clock position). Tighten about 1/4 turn with screwdriver until it locks into place. (Fig. 6) Repeat this step for remaining 4 Cam Pins. The Cam Pin is a steel to steel assembly which ensures heavy duty strength when assembled.

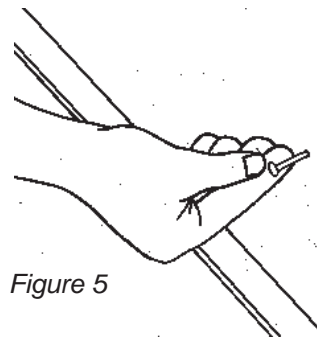
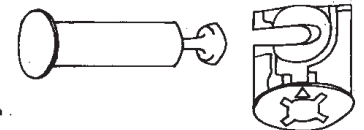
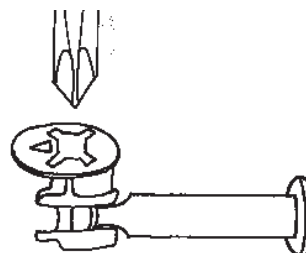

Figure 5



Cam pin is inserted through panel into preinstalled fitting.

Figure 6



Check to verify that arrow is pointing perpendicular to pin when cam is locked.

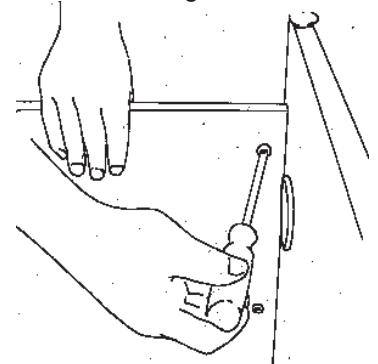

(Once Back Panel is secured to Left and Right Side Panels, the "shell" of the desk is assembled. See Figure 7 on next page)

Figure 7 Smartdesks Flip-it Series Double Station with Back & Side Panels assembled.

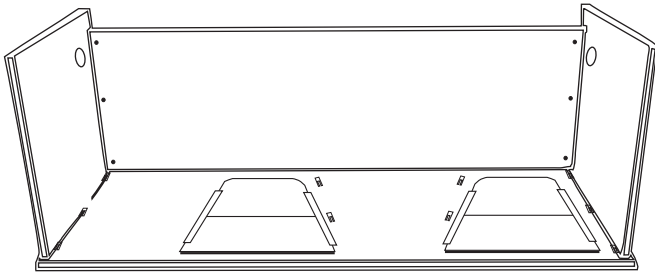

Figure 7

### STEP 3 - Support Panel (CPU) Cabinet Assembly

NOTE: 1 person assembly required for proper fit.

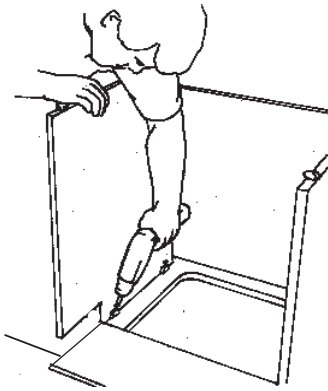

Figure 8

The Double Series Workstation has 3 Support Panels. Assemble the Support Panel closest to the End Panel first. Hold the Support Panel in 90° vertical position with the corner notch facing away from Back Panel. (This allowance is for the Keyboard/Hinge Mechanism.) Match RV Fittings to one another and snap panel into place. Use power drill to tighten the screw contained in the RV Fitting. (Fig. 8) Cam Pin holes in Back Panel should align with Cams in the Support Panel. Insert Cam Pin through back panel into cam fitting. (Fig. 9) You may have to flex Back Panel up and down slightly to get Cam Pin to slide into hole. Tighten with screwdriver until it locks into place. Check to verify that the arrow is facing out. Repeat this step for remaining Cam Pin. The Support Panel is now locked into position.

Repeat STEP 3 for the installation of remaining support panels.

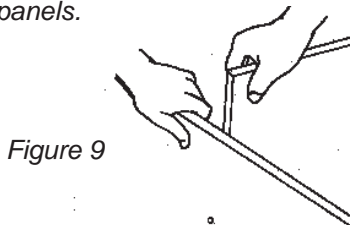
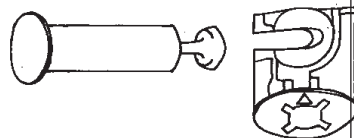

Figure 9



Cam pin is inserted through panel into preinstalled fitting.



### STEP 4 - Installation of CPU Bottom

NOTE: 1 person assembly required for proper fit.

The CPU Bottom is not adjustable. Make sure arrows on Cams are facing out. Slide the CPU bottom into position. (Fig10) Aligning the CPU Bottom with the predrilled holes, insert Cam Pin through the CPU Side Panel into cam fitting. Tighten with screwdriver until it locks into place. Repeat this step for remaining 3 Cam Pins. (Fig. 11)

Repeat STEP 4 for the installation of remaining CPU Bottom

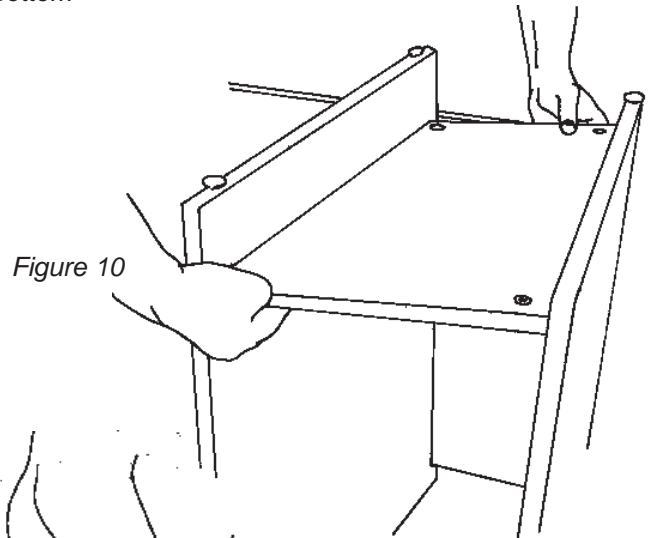

Figure 10

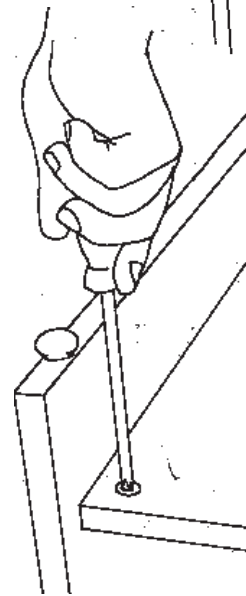
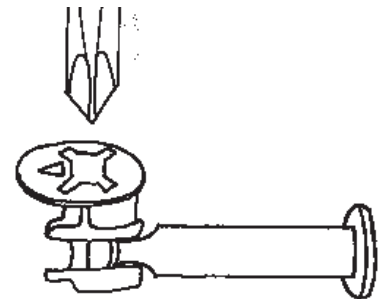

Figure 11



Check to verify that arrow is pointing perpendicular to pin when cam is locked.

**STEP 6 - Flip Desk 180° to Upright Position**

*Note: 2 persons required for this step.*

Roll desk on to its back then to upright position.

**NOTE: CUT THE NYLON CABLE TIE FROM THE KEYBOARD HINGE AFTER THE DESK IS ASSEMBLED AND UPRIGHT.**

**STEP 7 - Installation of Wire Trough**

Once computer and wiring is installed, the black PVC Wire Trough can be used to neatly contain wiring. Position black plastic Wire Trough near grommet in Side Panel and near notches at Center Panel. Hold Wire Trough approx. 1" up from bottom of Back Panel in line with gromets and scallops on dividers. Peel off PSA tape on rear of Wire Trough and stick to inside rear of Back Panel.

*Repeat STEP 7 for the installation of remaining Wire Trough*

*Smartdesks have been designed and tested as an ergonomically correct and space saving unit. For more information on this and other Smartdesks products, call 1-800-770-7042 or visit our website at <http://www.smartdesks.com>*



**Smartdesks Model DFI-723030-TKF**

---

**See flipIT LCD Monitor Installation Instructions for securing of LCD Flat Display \* to flipIT™ Rotating Desktop Panel**