



SMARTdesks™ MPLEX™ Product Specs

MLT-302642-xxL Single Bay Open Lectern for Laptop Computer

Materials and Construction Specifications

Top Surface - 0.048" thick, high-pressure laminate (exceeds performance requirements of NEMA 3-1995 Grade HGS) bonded to 30mm thick 50 lb. medium density particleboard with phenolic resin impregnated backer sheet. All edges are banded in 3mm thick, color-thru PVC mechanically applied under pressure and heat. Power/Data Port with duplex outlet and two cat.5 ports mounted in worksurface.

Open Bay – Inside dimensions are 28.5" wide x 23" deep. Includes two half-depth fixed storage shelves.

Base Panels - 0.020" thick melamine coated finish thermally fused to both sides of 19mm thick 47 lb. medium density particleboard. All exposed edges (including bottom edges in contact with the floor - to prevent water damage) are banded in 3mm thick, color-thru PVC mechanically applied under pressure and heat.

Construction – European 32mm woodworking technology employing steel-to-steel pin and cam connections (thru-drilled for full panel integrity) where needed to provide durability, ease of assembly and modularity.

Integral Wire Management™ - Horizontal wire channeling, 80mm side access grommets are positioned to align with other components and wall power/data access points.

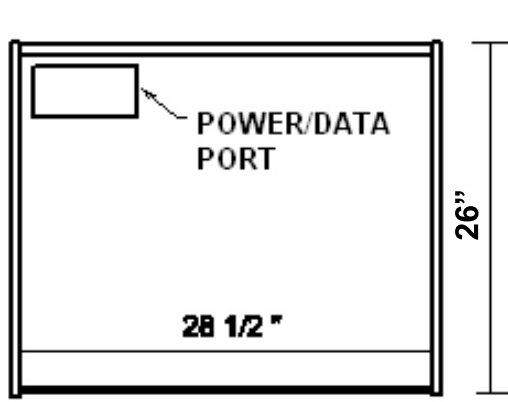

TOP

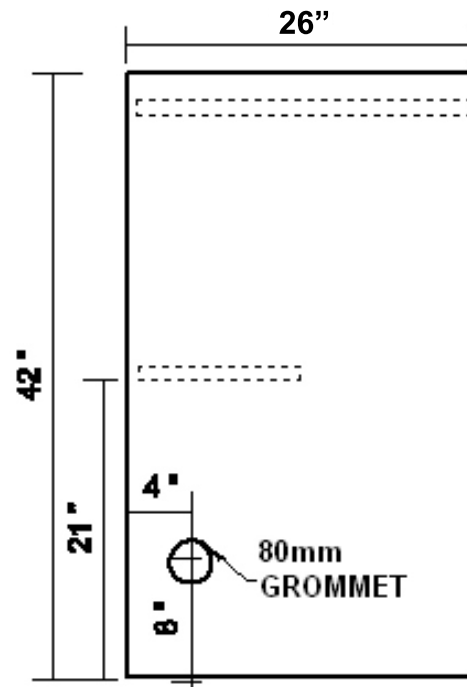

SIDE

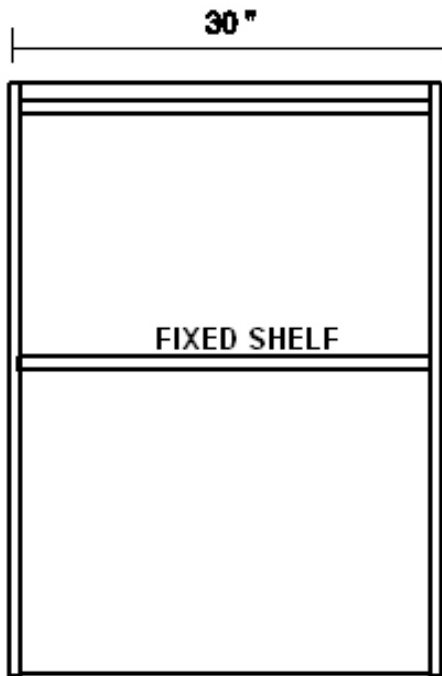

FRONT

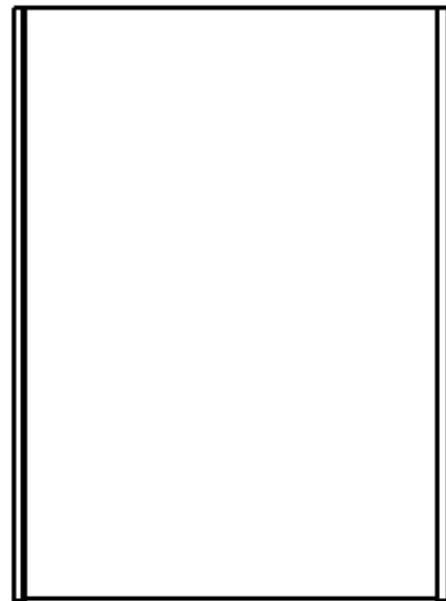

REAR