

Panel List

Note: Separate and stack panels by like types before beginning assembly process.

- 1 Desk Top Panel • 1 Back Panel • 1 Left End Panel • 1 Right End Panel • 1 Vertical Partition •
- 1 Stretcher Panel • 1 Monitor Shelf • 1 Keyboard/Mouse Platforms • 2 Storage Shelves
- 1 Storage Door • 1 Left CPU Door • 1 Right CPU Door • 1 Vertical Partition

- = Cam Fitting
- = Cam Hole
- = Screw Hole/Spoon Pin
- = RV Fitting
- = Hinge
- ▲ = Screw Hole/Casters

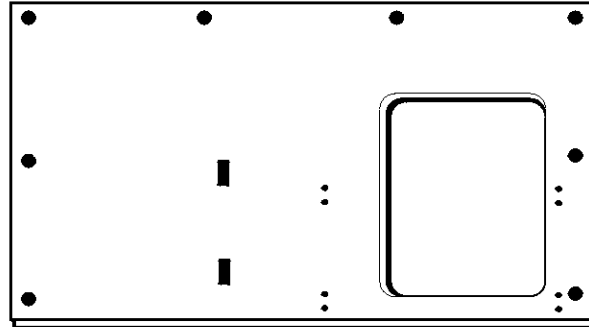

Lectern Top Panel (1 ea.)

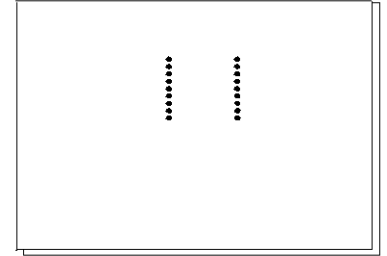

Monitor Shelf (1 ea.)

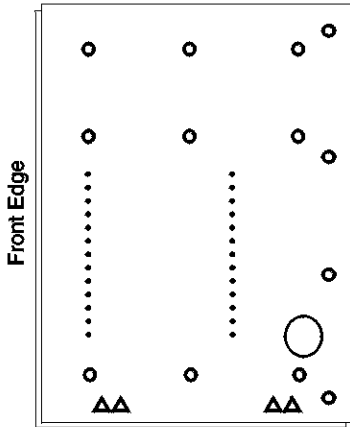

Left End Panel (1 ea.)

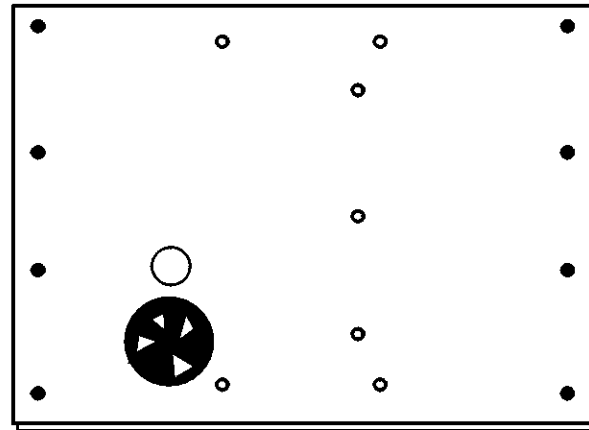

Back Panel (1 ea.)

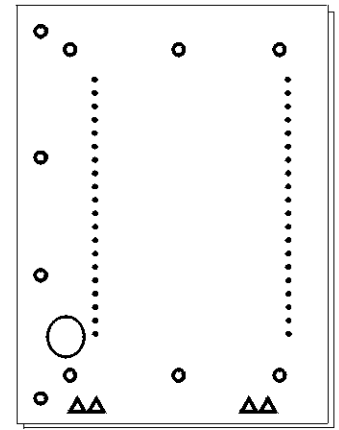

Right End Panel (1 ea.)



Keyboard/Mouse Platform (1 ea.)

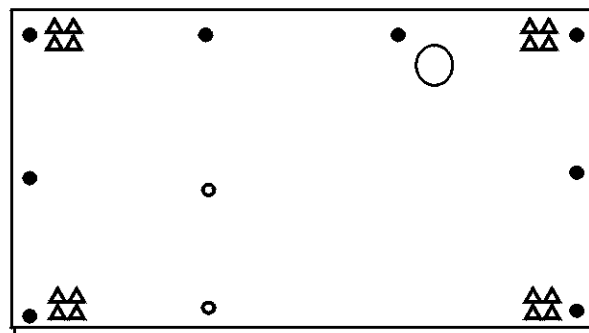

Bottom Panel (1 ea.)



Stretcher Panel (1 ea.)

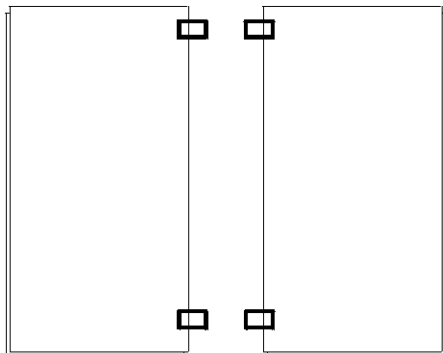

Left CPU Door (1 ea.)

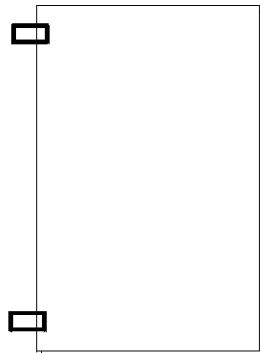

Right CPU Door (1 ea.)

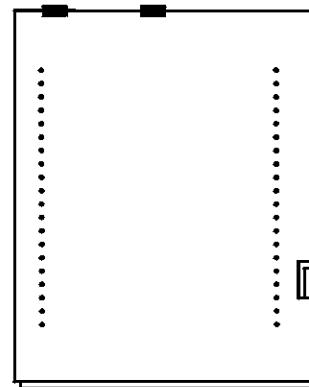

Storage Door (1 ea.)

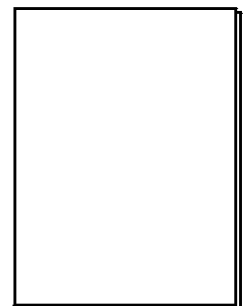

Storage Shelf (2 ea.)

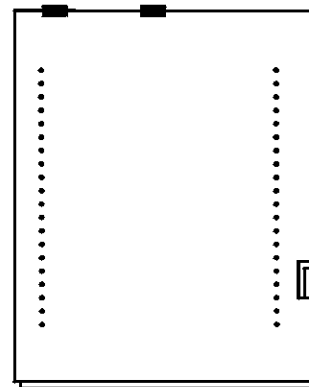

Vertical Partition (1 ea.)

Smartdesks are packaged ready to be assembled. Included is a Master Parts and Panel List showing diagrams of all parts and hardware required for assembly. Please note, improper installation may void the Smartdesks warranty. To install correctly follow the enclosed instructions. If you need additional assistance or information please contact Technical Service at 410-922-6005. © Copyright Smartdesks 1999. All rights reserved.

Hardware Inventory Sheet

2 persons are needed to assemble Smartdesks Model MLSS 54

Unpack Parts and Hardware:

Parts and panels will vary according to Smartdesks model. See Parts & Panels List and Hardware Inventory Sheet. Please verify all parts and quantities prior to assembly. Contact the factory if your quantities are incomplete. *Note: All panels are predrilled ready for assembly.*

Note: Also included in this package is a premanufactured keyboard/mouse platform support assembly for use with keyboard/mouse platform. Please follow separate assembly instructions.

Tools needed for assembly:

- Power drill with #2 Phillips screwdriver bit and regular #2 Phillips screwdriver.
- 7/16" wrench used for assembly of nuts on caster bolts.

The following diagram shows the contents of the hardware bag.

Contents of Hardware Bag : (quantities for each lectern - multiply by number of lecterns)

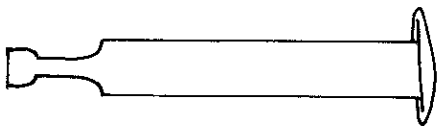

35 ea. - Cam Pins
push through holes in panels.
(Side Panels, Back Panels,
Support Panels)

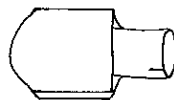

8 ea.- Shelf Spoon Pins
for Monitor Shelf (rear holes)
and CPU Shelf (front holes)

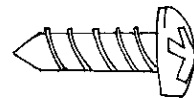

**8 ea. - Mounting
Bracket Screws**
for keyboard bracket

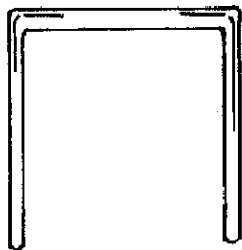

**1 ea. - Wire Monitor
Support Wickets**
for Monitor Shelf

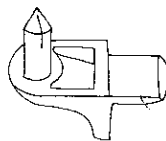

6 ea. - Earthquake Pins
for Convertible CPU Cabinet
Shelf (front holes only)
Monitor Shelf (front holes only)

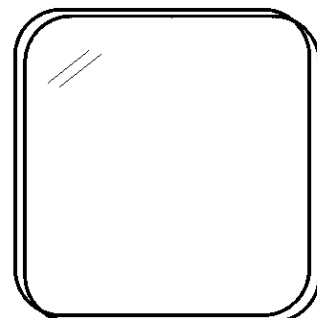

**1 ea. - Tinted Glass Monitor
Window**
for Desk Top

Hardware Inventory Sheet (Cont.)

2 persons are needed to assemble Smartdesks Model MLSS 54

Contents of Hardware Bag : (quantities for each lectern - multiply by number of lecterns)



12 ea. - 5mm Hinge Plate Screws for Caster Plate



6 ea. - Hinge Plate Locking Screws for Caster Plate



6 ea. - Hinge Plate Screw Cover Caps to cover Hinge Plate Screws

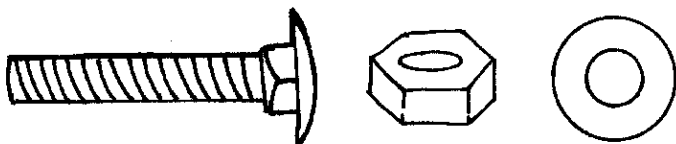

16 ea. - 1 1/2" Caster Bolts, Nuts & Washers for Caster Plate top

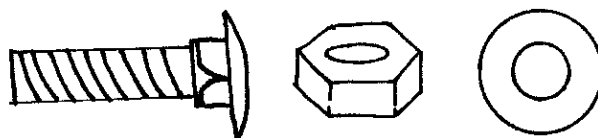

8 ea. - 1 1/4" Caster Bolts, Nuts & Washers for Caster Plate side

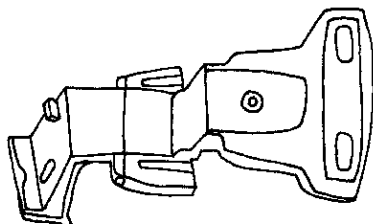

6 ea. - Hinge Plates

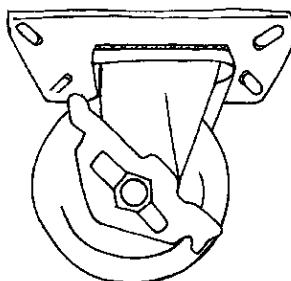

4 ea. - Casters
Wheels for Lectern.
Mounts to Caster Plate

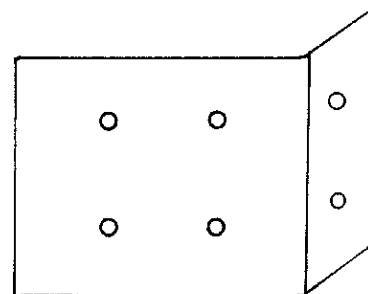

4 ea. - Caster Plate
mount to lectern bottom
and side

Smartdesks have been designed and tested as an ergonomically correct and space saving unit. For more information on this and other Smartdesks products, call 1-800-770-7042 or visit our website at <http://www.smartdesks.com>

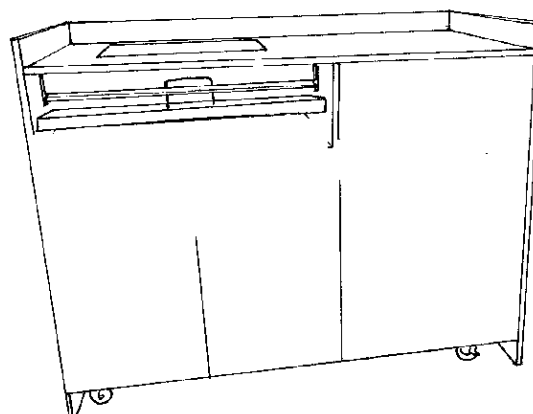

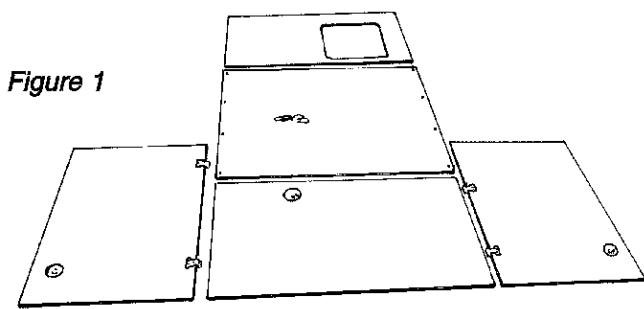

Figure 1

STEP 1 - Side Panel and Bottom Assembly

NOTE: 2 person assembly required for proper fit.

In a clean work area lay panels facing up on the floor on cardboard or carpet/packing quilt. (Top, Left Side, Right Side, Back, Bottom) (Fig. 1) Fan is preinstalled onto Back Panel. Insert Cam Pins through Side Panels and lay Side Panels flat with Cam Pins showing through. (Fig. 2)

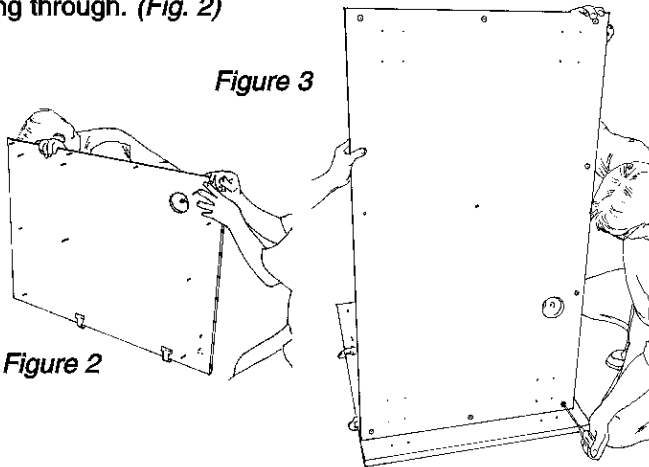

Figure 3

Figure 2

Lift Bottom Panel into 90° vertical position. Place Bottom Panel onto Left Side Panel. Cam Pins will match cam fittings of Bottom Panel. (Fig.3) It is necessary for 2 people to accomplish this assembly. Vertical panels cannot be left standing unsupported. Make sure arrows on Cam Pins are facing out. Tighten about 1/4 turn with screwdriver until it locks into place. (Fig. 4) Repeat this step for remaining 2 Cam Pins. The Cam Pin is a steel to steel assembly which ensures heavy duty strength when assembled.

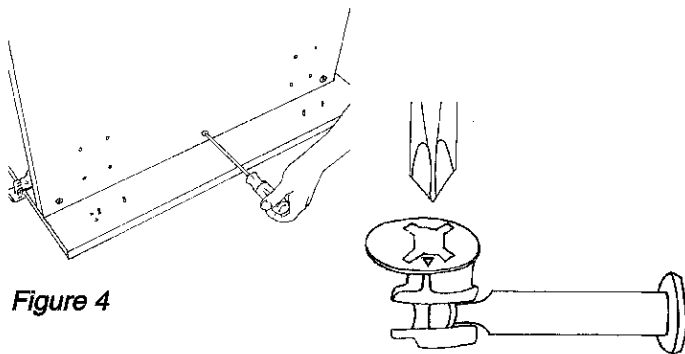

Figure 4

Check to verify that arrow is pointing perpendicular to pin when cam is locked.

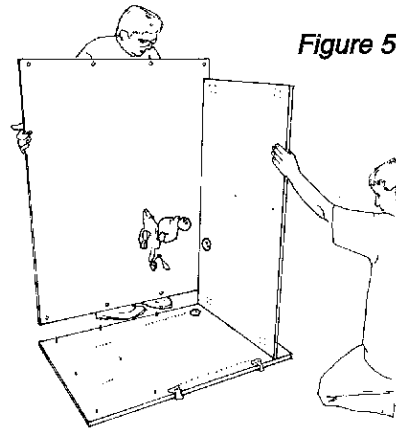

Figure 5

STEP 2 - Back Panel To Side and Bottom Assembly

NOTE: 2 person assembly required for proper fit.

With the Left Side Panel laying flat and Bottom Panel in vertical position, slide Back Panel into vertical position matching the cam fittings to the Cam Pins on each panel. (Fig.5) The lectern will now be standing on its side with the Side Panel and Bottom forming a corner. This provides a sturdy base from which to build the remaining pieces of the lectern. It is necessary for 2 people to accomplish this assembly. Vertical panels cannot be left standing unsupported. Make sure arrows on Cam Pins are facing out. Tighten about 1/4 turn with screwdriver until it locks into place. (Refer to Fig. 4) Repeat this step for remaining 2 Cam Pins.

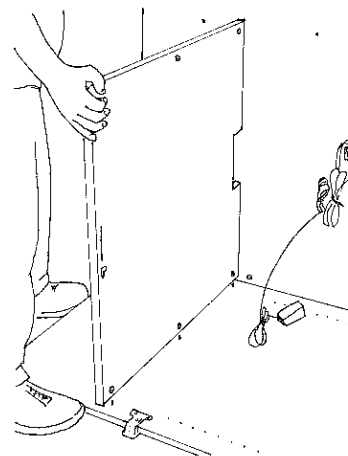

Figure 6

STEP 3 - Monitor Compartment Divider Assembly

NOTE: 1 person assembly required for proper fit.

Lift Monitor Compartment Divider to 90° vertical position. Place Monitor Compartment Divider onto Side Panel. Notched side of Monitor Compartment Divider will face the Back Panel. Cam fittings of Monitor Compartment Divider will match Cam Pins of Left Side Panel. (Fig.6) Make sure arrows on Cam Pins are facing out. Tighten about 1/4 turn with screwdriver until it locks into place. (Refer to Fig. 4) Repeat this step for remaining 2 Cam Pins.

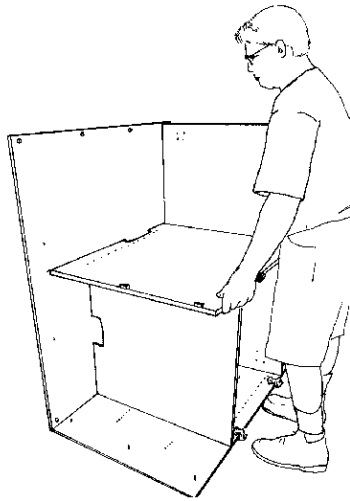

Figure 7

STEP 4 - Vertical Partition Assembly

NOTE: 1 person assembly is required for proper fit.

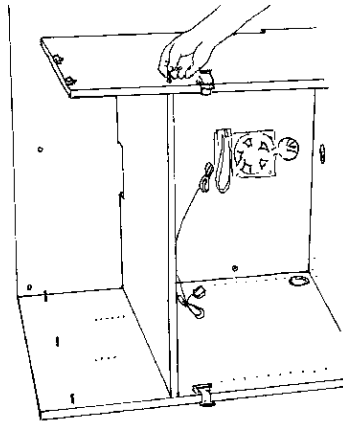

Figure 8

Lift and place Vertical Partition into position with the cut out facing Back Panel. Match the cam fittings to the Cam Pins on the Vertical Partition. (Fig. 7) Insert Cam Pin through Vertical Partition into cam fitting of Monitor Compartment Divider. (Fig. 8) Make sure arrows on Cam Pins are facing out. Tighten about 1/4 turn with screwdriver until it locks into place. (Refer to Fig. 4) Repeat this step for remaining 2 Cam Pins. Insert Cam Pin through Bottom Panel into cam fitting. Tighten with screwdriver until it locks into place. (Fig. 9)

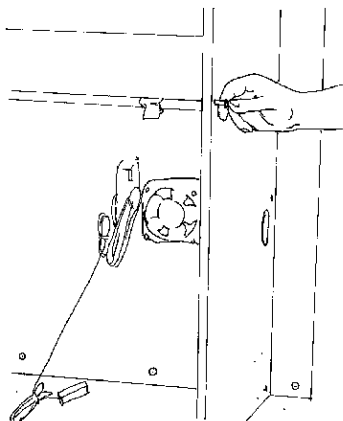

Figure 9

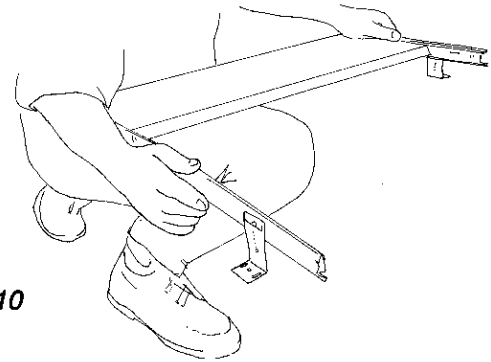
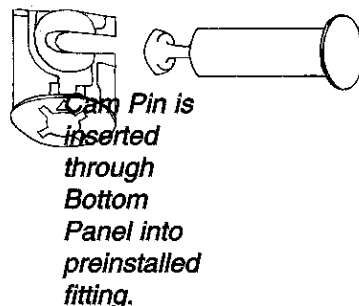

Figure 10

STEP 5 - Mounting Keyboard/Mouse Platform Hardware

Follow installation instructions for Keyboard/Mouse Platform hardware contained in Keyboard/Mouse Platform hardware kit. Once assembled, keyboard slide must be mounted parallel to side and perpendicular to the work surface front. Assemble left and right Keyboard/Mouse Platform pull-out supports by sliding on a set of matching mounting brackets with tabs of mounting brackets facing outward. (Fig. 10) Keyboard/Mouse Platform is now ready to be mounted to desk top. With bracket screw holes aligning the pre drilled holes in Top Panel, position Keyboard/Mouse Platform for mounting. 1/8" lip is located at the rear and top side of the Keyboard/Mouse Platform. Tighten the Mounting Bracket Screw into Top Panel making sure tabs of mounting brackets are facing out. (Fig. 11) 2 Mounting Bracket Screws are used in each bracket. Tighten remaining Mounting Bracket Screws to complete mounting of Keyboard/Mouse Platform. (Fig. 12)

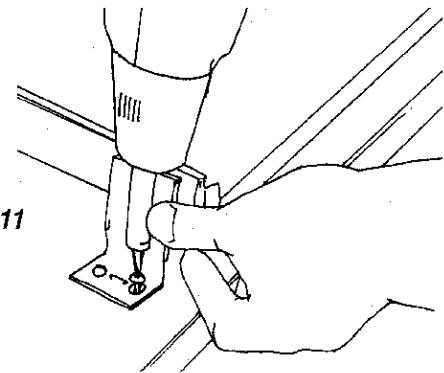

Figure 11

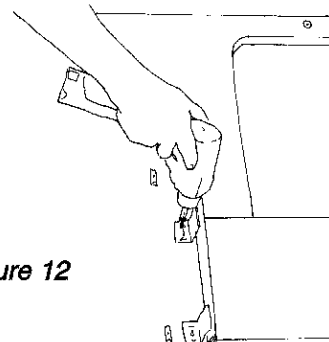

Figure 12

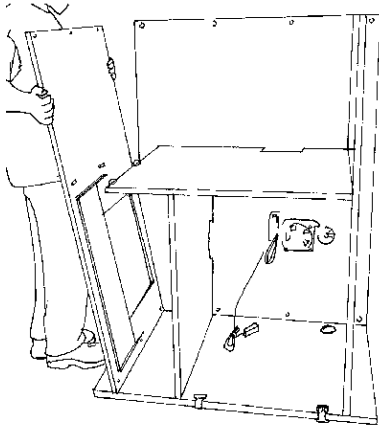

Figure 13

Step 6 - Top Panel to Side and Back Assembly

Lift Top Panel into 90° vertical position. Place Top Panel onto Left Side Panel. While holding Top Panel in vertical position, match RV Fittings to one another and snap panel into place. Use power drill to tighten the screw contained in the RV Fitting. (Fig.13) Each RV Fitting contains a screw to lock the hardware once the panels have been snapped into place. Warranty is void if all locking screws have not been tightened. RV Fittings come preinstalled in panels and lock the Monitor Compartment Divider to the Top Panel into place. (Fig.14) Aligning Back Panel with the predrilled holes, insert Cam Pin through the Back Panel into cam fitting. (Fig.15) Make sure arrows on Cam Pins are facing out. Tighten about 1/4 turn with screwdriver until it locks into place. (Refer to Fig. 4) Repeat this step for remaining Cam Pins.

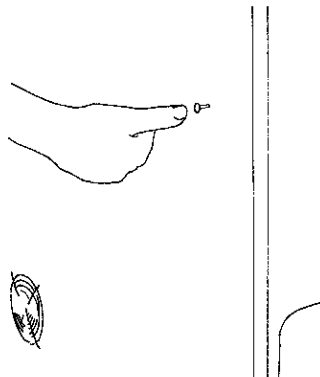

Figure 14

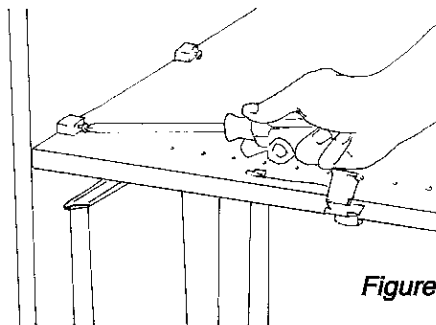

Figure 15

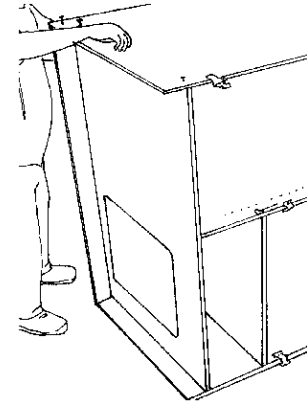

Figure 16

Step 7 - Right Side Panel to Top, Back, and Bottom Assembly

Lift and place Right Side Panel into position. The Right Side Panel has Cam Pin holes on three sides that will lock the Right Side Panel into place with the Top Panel, Back Panel and Bottom Panel once Cam Pins have been inserted and tightened. (Fig.16) Aligning Right Side Panel with the predrilled hole, insert Cam Pin through the Right Side Panel into cam fitting. Make sure arrows on Cam Pins are facing out. Tighten about 1/4 turn with screwdriver until it locks into place. (Refer to Fig. 4) Repeat this step for remaining Cam Pins.

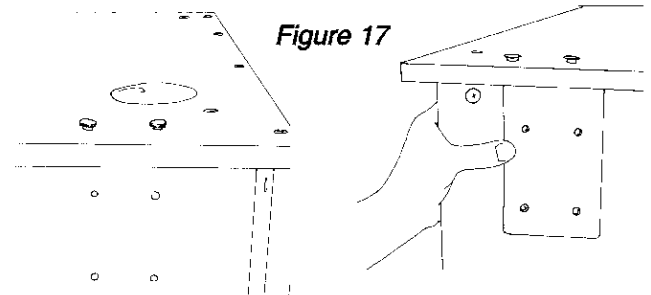

Figure 17

Step 8 - Wheel Bracket /Wheel Unit Assembly

Locate predrilled holes under wire grommet near the bottom of the Side Panel. Insert bolt through each of the 2 holes in Side Panel. (Fig. 17) Align holes in short end of Wheel Bracket to the bolts. Add washer to bolt and tighten nut with wrench. Repeat step for remaining bolt. Insert 4 screws through Bottom Panel and Wheel Bracket. Align and place Wheel Unit onto Wheel Bracket. Tighten and secure into place with 4 bolts. (Fig 18)

Repeat STEP 8 for installation of the 3 remaining Wheel Bracket/Wheel Units

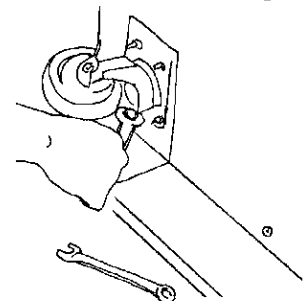

Figure 18

STEP 9 - Flip Lectern 90° to Upright Position

Note: 2 persons required for this step.

Roll lectern on to its wheels to upright position.

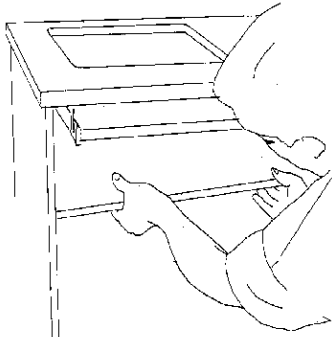

Figure 19

The Monitor Shelf is adjustable only until you achieve proper angle and height for your monitor. It is a trial and error approach until you find the best location for the pins. (Fig. 19)

Step 10- Installation of Monitor Shelf

NOTE: Use Shelf Spoon Pins for preliminary steps of this install. This allows you to test the placement of the monitor height before permanently attaching the shelf. Do not leave the shelf this way because you will void the warranty and the monitor may fall.

For a 17" monitor, insert 4 shelf pins in the fourth hole up from the bottom in the staggered rows of holes pre-drilled in the panel sides below the opening in the work surface. Temporarily slide the monitor shelf into place, allowing the shelf pins to slip into the cam slots on the underside of the shelf. Temporarily place the monitor on the shelf. The monitor should sit approximately 1/2" below the top of the surface and as far back as possible within the opening. You may also have to move the shelf and pins up or down to find the ideal location. For a 14" monitor, start the pins in the 6th hole up from the bottom. For 19" monitors, start at the second hole.

When you have determined the correct height, remove the monitor and shelf and replace the shelf pins with four 5mm Locking screws. (Fig. 20) Replace the shelf and tighten the cams on the underside of the shelf with a #2 Phillips screwdriver. Once the cams are tightened the shelf becomes a fixed structural member that prevents lateral movement from separating the panels and causing the support to collapse. Failure to tighten the locking cams will void the warranty.

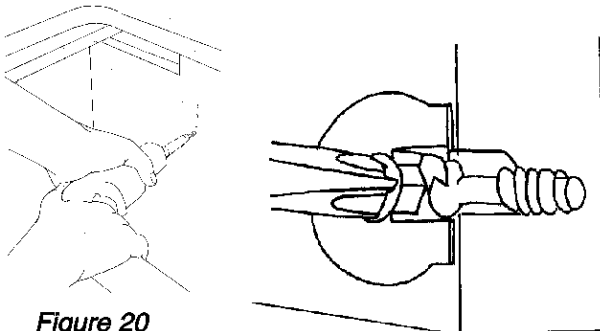

Figure 20

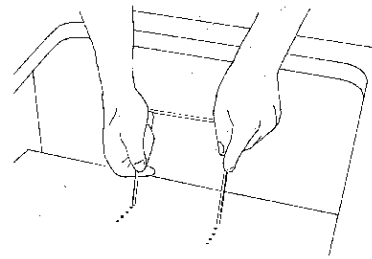

Figure 21

STEP 11 - Installation of Monitor Support Wicket

The Monitor Support Wicket holds the monitor forward on the Monitor Shelf. Before monitor is placed on the Monitor Shelf, insert Monitor Support Wicket into one of the sets of the predrilled holes on Monitor Shelf. (Fig. 21) Place monitor on Monitor Shelf. *NOTE: Monitor should sit as high and as far back as possible.*

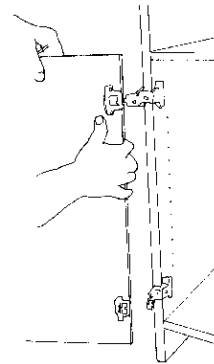

Figure 22

STEP 12 - Installation of CPU Doors

Place Left CPU Door to match hinge fittings of Left Side Panel. Snap hinge fittings together. (Fig. 22) Close CPU Door. Repeat this step for Right CPU Door.

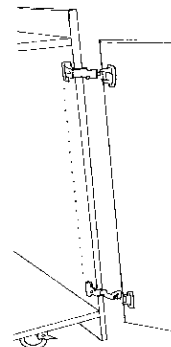

Figure 23

STEP 13 - Installation of Storage Door

Lift and place Storage Door to match hinge fittings of Right Side Panel. Snap hinge fittings together. (Fig. 23) Close Storage Door.

STEP 14 - Installation of Tinted Glass Monitor Window

Carefully place Tinted and Tempered Glass Monitor Window onto ledge flush to Lectern Top