

Panel List

Note: Separate and stack panels by like types before beginning assembly process.

- 1 Desk Top Panel • 1 Back Panel • 1 Left End Panel • 1 Right End Panel • 1 Support Panel
- 1 Monitor Shelf • 1 Keyboard/Mouse Platform • 1 CPU Bottom

- = Cam Fitting
- = Cam Hole
- = Screw Hole/Spoon Pin
- = RV Fitting

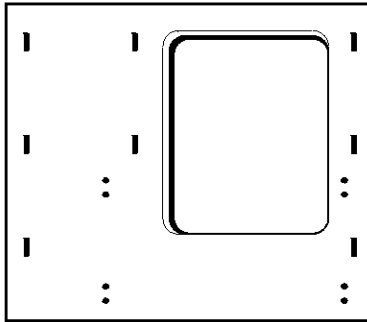

Desk Top Panel (1 ea.)

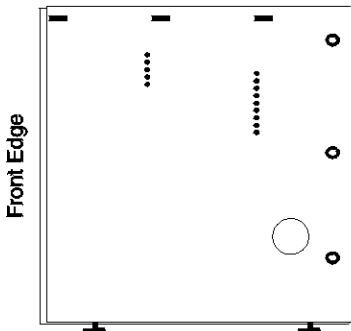

Left End Panel (1 ea.)

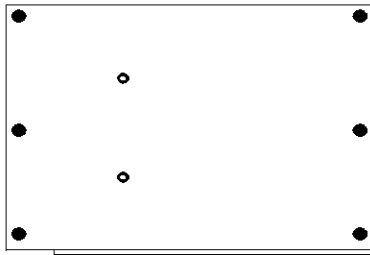

Back Panel (1 ea.)

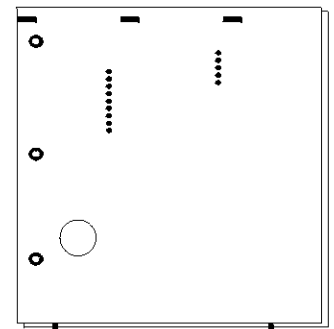

Right End Panel (1 ea.)

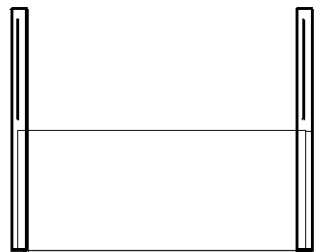

Keyboard/Mouse Platform (1ea.)

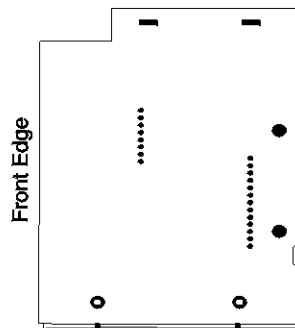

Support Panel (1 ea.)

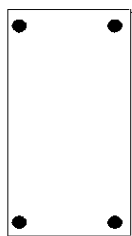

CPU Bottom (1 ea.)

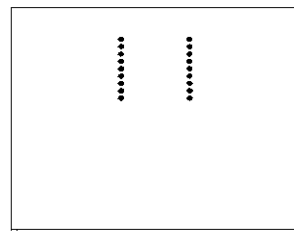

Monitor Shelf (1 ea.)

The Smartdesk is packaged ready to be assembled. Included is a Master Parts and Panel List showing diagrams of all parts and hardware required for assembly. Please note, improper installation may void Smartdesk warranty. To install correctly follow the enclosed instructions. If you need additional assistance or information please contact Technical Service at 410-922-6005. © Copyright Smartdesks Ltd. 1999. All rights reserved.

Hardware Inventory Sheet

1 person is needed to assemble Smartdesks Model SR 36

Unpack Parts and Hardware:

Parts and panels will vary according to Smartdesks model. See Parts & Panels List and Hardware Inventory Sheet. Please verify all parts and quantities prior to assembly. Contact the factory if your quantities are incomplete. *Note: All panels are predrilled ready for assembly.*

Note: Also included in this package is a premanufactured keyboard shelf assembly for use with keyboard shelf. Please follow separate assembly instructions.

Tools needed for assembly:

Power drill with #2 Phillips screwdriver bit and regular #2 Phillips screwdriver.

The following diagram shows the contents of the hardware bag.

Contents of Hardware Bag : (quantities for each desk - multiply by number of desks)

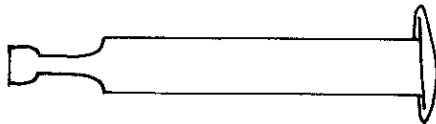

12 ea. - Cam Pins
push through holes in panels.
(Side Panels, Back Panel,
Support Panel)

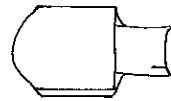

4 ea.- Shelf Spoon Pins
for Monitor Shelf (rear holes)
and CPU Shelf (front holes)

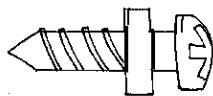

4 ea. - 5mm Locking Screws
1 pair for each Monitor
Shelf front.

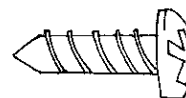

**8 ea. - Mounting
Bracket Screws**
for keyboard bracket

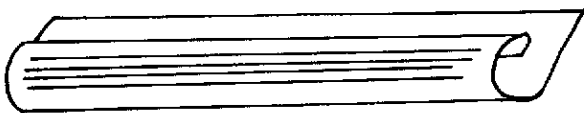

1 ea. - Wire Trough
black PVC used to contain
wiring inside rear of
Back Panel

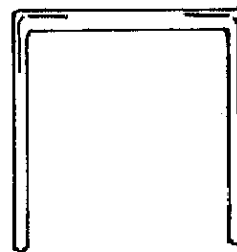

**2 ea. - Wire Monitor
Support Wickets**
for Monitor Shelf

Figure 1

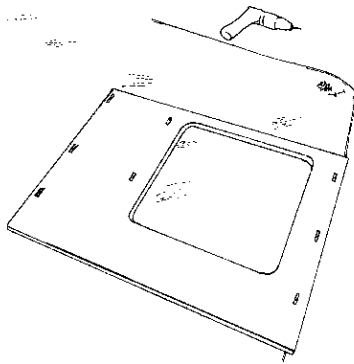

STEP 1 - Desk Top & Side Panel Assembly

In a clean work area lay Desk Top Panel with desk top facing down on the floor on cardboard or carpet/packing quilt. (Fig. 1)

Figure 2

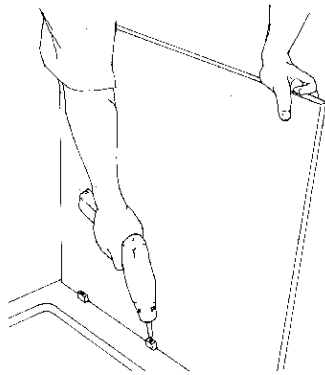

Lift and place Right Side Panel into 90° vertical position with fittings facing in. While holding right panel in vertical position, match RV Fittings to one another and snap panel into place. Use power drill to tighten the screw contained in the RV Fitting. (Fig.2) Each RV Fitting contains a screw to lock the hardware once the panels have been snapped into place. Warranty is void if all locking screws have not been tightened. RV Fittings come preinstalled in panels and are equally spaced along Desk Top edge. Tighten all remaining RV Fittings along panel edge. (Fig.3)

Repeat STEP 1 for the installation of the Left Side Panel.

Figure 3

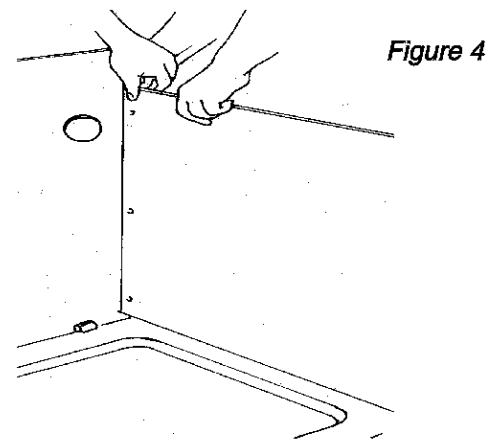
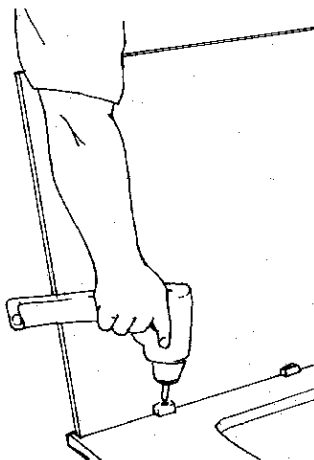

Figure 4

STEP 2 - Back Panel To Sides Assembly

NOTE: 1 person assembly required for proper fit.

Slide Back Panel into position between two Side Panels matching the cam fittings to the holes at top. It is necessary for 2 people to accomplish this assembly. Vertical panels cannot be left standing unsupported (Fig.4) Insert top 2 Cam Pins through Left and Right End Panels into cam fittings. (Fig. 5) Start at the top cam of each end panel when inserting Cam Pins and move down each end panel alternating as Cam Pins are inserted. Make sure arrows on Cam Pins are facing out (3 pm clock position). Tighten about 1/4 turn with screwdriver until it locks into place.(Fig. 6) Repeat this step for remaining 4 Cam Pins. The Cam Pin is a steel to steel assembly which ensures heavy duty strength when assembled.

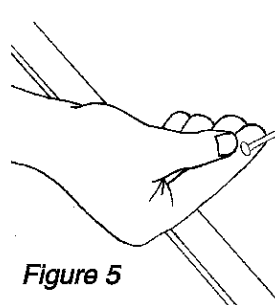

Figure 5

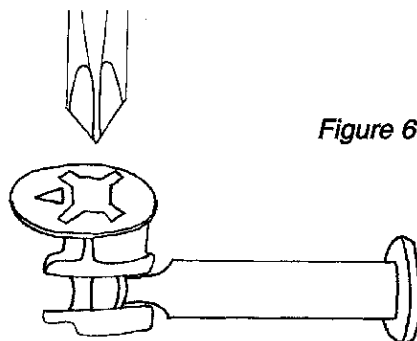
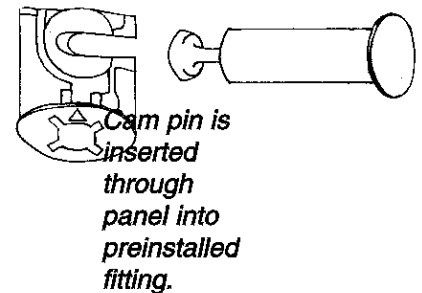
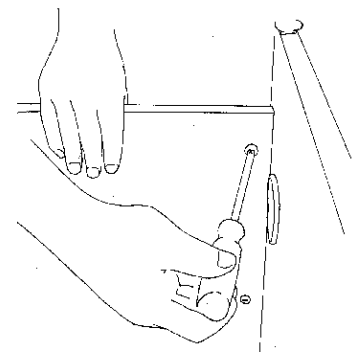

Figure 6

Check to verify that arrow is pointing perpendicular to pin when Cam is locked.



(Once Back Panel is secured to Left and Right Side Panels, the "shell" of the desk is assembled. See Figure 7 on next page)

Figure 7 Smartdesks with Back & Side Panels Assembled

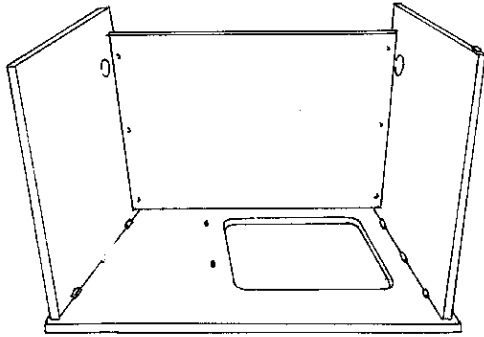

STEP 3 - Center Support Panel CPU Cabinet Assembly

NOTE: 1 person assembly is required for proper fit.

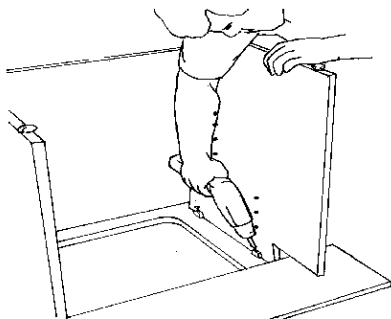

Figure 8

Hold Center Support Panel in 90° vertical position with the corner notch facing away from Back Panel. (This allowance is for the Keyboard/Mouse Platform.) Match RV Fittings to one another and snap panel into place. Use power drill to tighten the screw contained in the RV Fitting. (Fig. 8) Cam Pin holes in Back Panel should align with Cams in Center Support Panel. Insert Cam Pin through back panel into cam fitting. (Fig. 9) You may have to flex Back Panel up and down slightly to get Cam Pin to slide into hole. Tighten with screwdriver until it locks into place. Check to verify that the arrow is facing out. Repeat this step for remaining Cam Pin. The Center Support Panel is now locked into position.

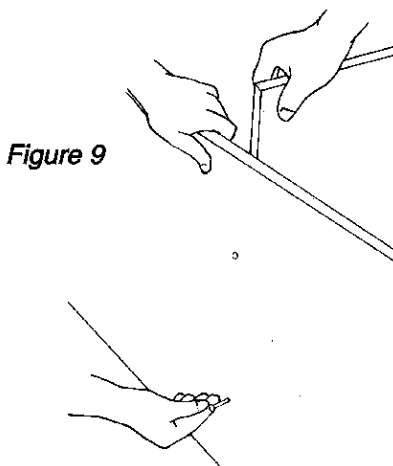
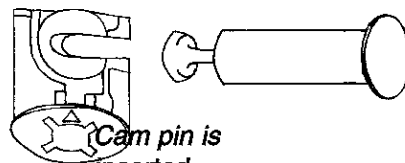

Figure 9



Cam pin is inserted through Back Panel into preinstalled fitting.

STEP 4 - Installation of CPU Bottom

NOTE: 1 person assembly required for proper fit.

The CPU Bottom is not adjustable. Make sure arrows on Cams are facing out. Slide the CPU bottom into position. (Fig10) Aligning the CPU Bottom with the predrilled holes, insert Cam Pin through the CPU Side Panel into cam fitting. Tighten with screwdriver until it locks into place. Repeat this step for remaining 3 Cam Pins. (Fig. 11)

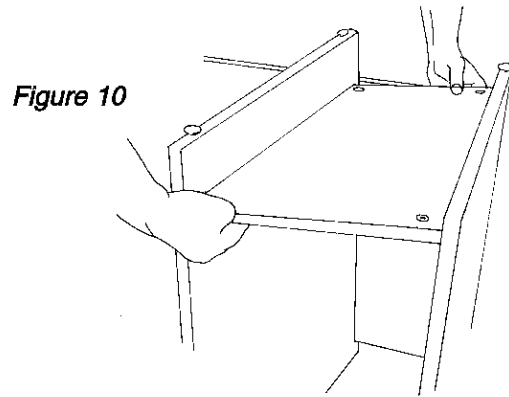

Figure 10

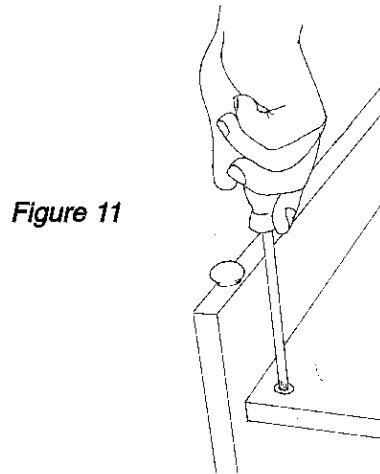
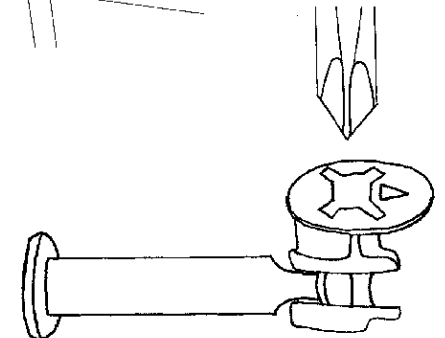
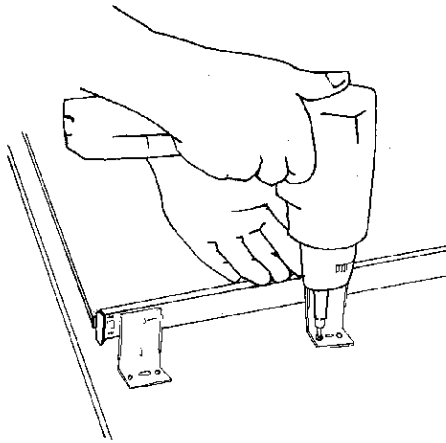

Figure 11



Check to verify that arrow is pointing perpendicular to pin when Cam is locked.

Figure 12



STEP 5 - Mounting Keyboard/Mouse Platform Hardware

Follow installation instructions for Keyboard/Mouse Platform hardware contained in Keyboard/Mouse Platform hardware kit. Once assembled, each keyboard slide must be mounted parallel to each side and perpendicular to the work surface front. Assemble left and right Keyboard/Mouse Platform pull-out supports by sliding on a set of matching mounting brackets with tabs of mounting brackets facing outward. Keyboard/Mouse Platform is now ready to be mounted to desk top. With bracket screw holes aligning the pre drilled holes in Desk Top Panel, position Keyboard/Mouse Platform for mounting. 1/8" lip is located at the rear and top side of the Keyboard/Mouse Platform. Tighten the Mounting Bracket Screw into Desk Top Panel making sure tabs of mounting brackets are facing out. (Fig. 12) 2 Mounting Bracket Screws are used in each bracket. Tighten remaining Mounting Bracket Screws to complete mounting of Keyboard/Mouse Platform. (Fig. 13)

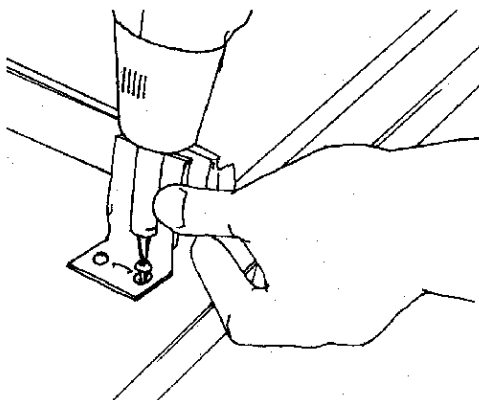

Figure 13

STEP 6 Flip Desk 180° to Upright Position

Note: 1 person required for this step.

Roll desk on its back then to its upright position.

Step 7 - Installation of Monitor Shelf

NOTE: Use Shelf Spoon Pins for preliminary steps of this install. This allows you to test the placement of the monitor height before permanently attaching the shelf. Do not leave the shelf this way because you will void the warranty and the monitor may fall.

For a 17" monitor, insert 4 shelf pins in the fourth hole up from the bottom in the staggered rows of holes pre-drilled in the panel sides below the opening in the work surface. Temporarily slide the monitor shelf into place, allowing the shelf pins to slip into the cam slots on the underside of the shelf. Temporarily place the monitor on the shelf. The monitor should sit approximately 1/2" below the top of the surface and as far back as possible within the opening. You may also have to move the shelf and pins up or down to find the ideal location. For a 14" monitor, start the pins in the 6th hole up from the bottom. For 19" monitors, start at the second hole.

When you have determined the correct height, remove the monitor and shelf and replace the shelf pins with four 5mm Locking screws. (Fig. 14) Replace the shelf and tighten the cams on the underside of the shelf with a #2 Phillips screwdriver. Once the cams are tightened the shelf becomes a fixed structural member that prevents lateral movement from separating the panels and causing the support to collapse. Failure to tighten the locking cams will void the warranty.

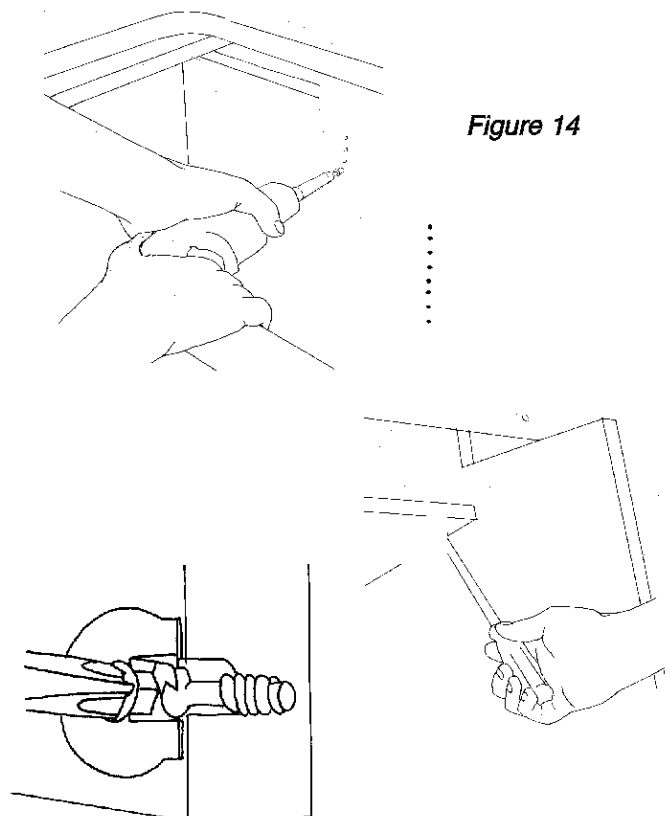

Figure 14

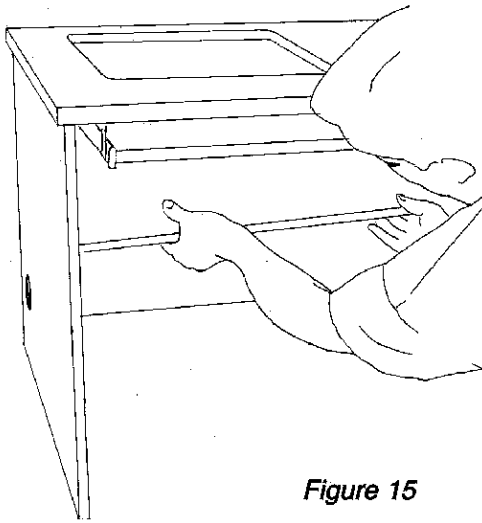

Figure 15

(Fig. 15) The Monitor Shelf is adjustable only until you achieve proper angle and height for your monitor. It is a trial and error approach until you find the best location for the pins.

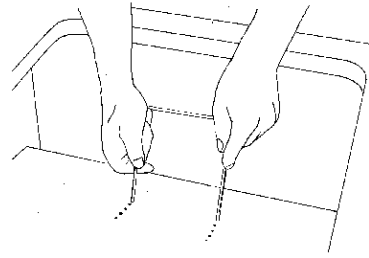

Figure 16

STEP 8 - Installation of Monitor Support Wicket

The Monitor Support Wicket holds the monitor forward on the Monitor Shelf. Before monitor is placed on the Monitor Shelf, insert Monitor Support Wicket into one of the sets of the predrilled holes on Monitor Shelf.

(Fig. 16) Place monitor on Monitor Shelf.

NOTE: Monitor should sit as far forward as possible without obstructing access to monitor controls.

STEP 9 - Installation of Wire Trough

Once computer and wiring is installed, the black PVC Wire Trough can be used to neatly contain wiring. Position black plastic Wire Trough near grommet in Side Panel and near notches at Center Panel. Hold Wire Trough approx. 1" up from bottom of Back Panel in line with gromets and scallops on dividers. Peel off PSA tape on rear of Wire Trough and stick to inside rear of Back Panel.

Smartdesks have been designed and tested as an ergonomically correct and space saving unit. For more information on this and other Smartdesks products, call 1-800-770-7042 or visit our website at <http://www.smartdesks.com>

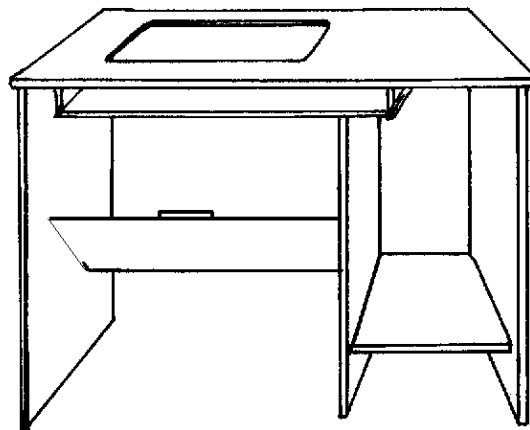

Smartdesks Model SR 36